

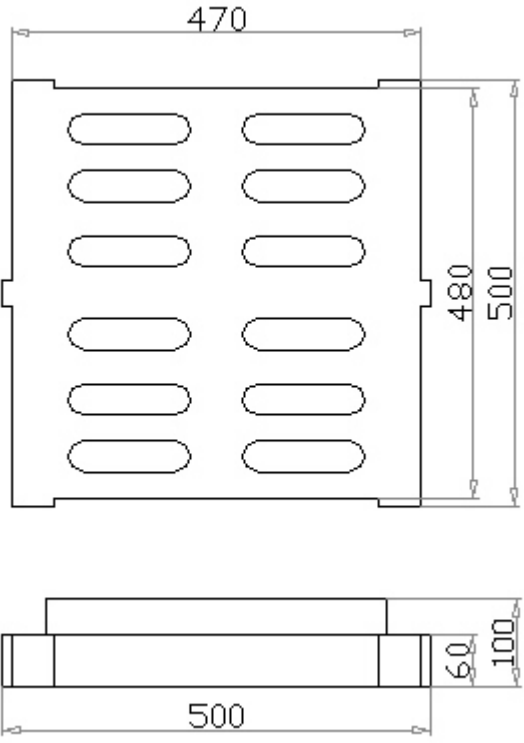





## Katalog kanálových vpustí

Pryžové kanálové vpustě a mříže jsou vyrobeny z recyklované pryže a jejich nosnost a pevnost zaručuje ocelová výztuha. Kanálová mříž může být umístěna do stávající litinové vpusti nebo naopak do pryžového rámu lze vsadit litinovou mříž. Výrobek splňuje podmínky dle ČSN EN 124 a je zatříděn do C 250 (zaručená minimální únosnost 25 tun) a D400 (zaručená minimální únosnost 40 tun).



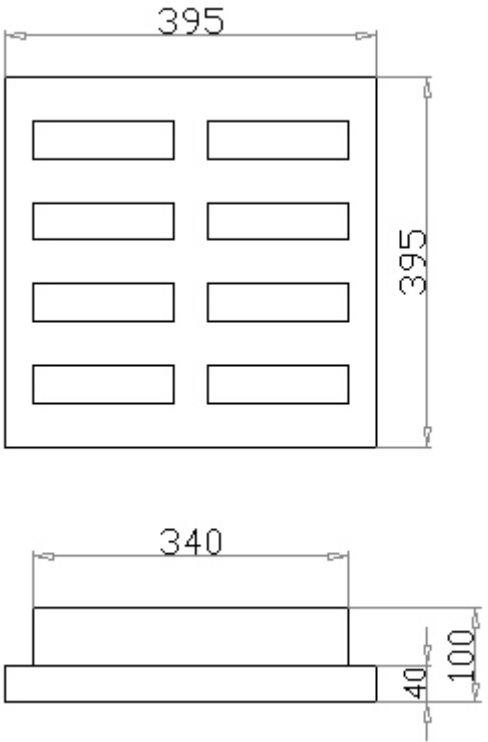

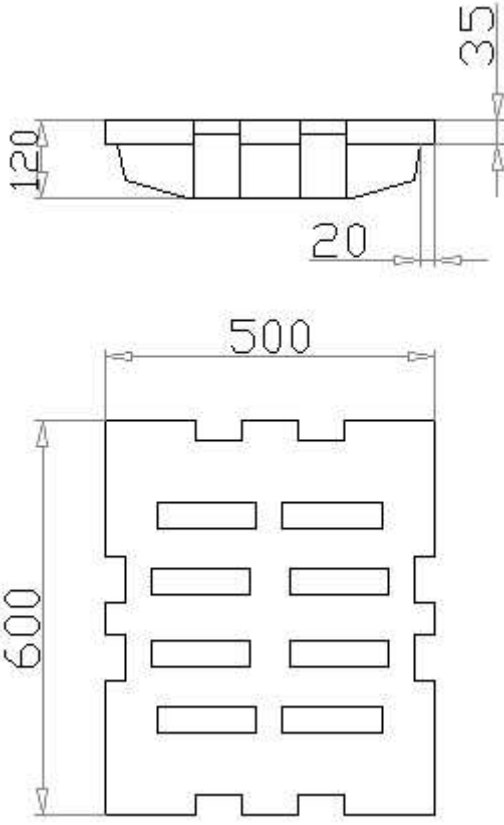
Pryžová vpust' je srovnatelná se stávajícími litinovými výrobky a určité vlastnosti má lepší. Pryž tlumí nárazy a je tišší šetrnější k podloží, omezuje vydrolení spoje s asfaltem, je mrazuvzdorná a zdravotně nezávadná.



<b>1a</b>	<b>Rozměr:</b> 480x480x100	
<b>Váha:</b>	28 kg	
<b>Zatížení:</b>	C250, D400	
		
Mříž		

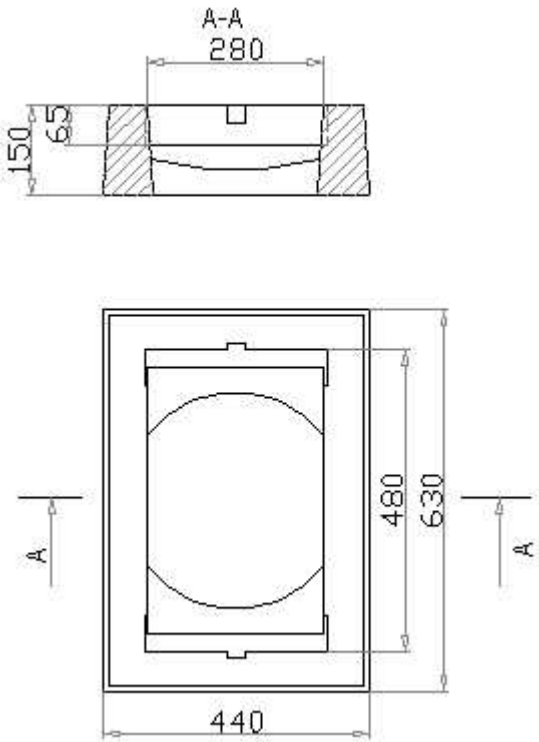

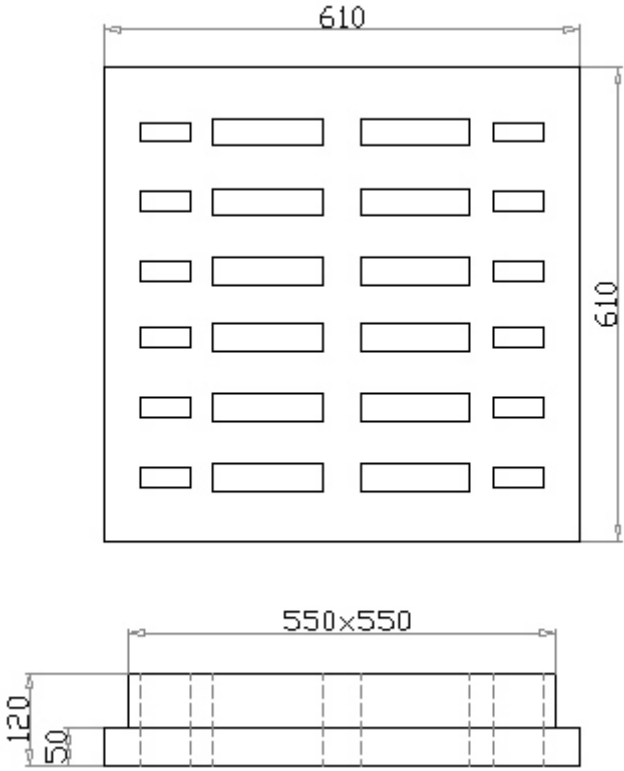

<p><b>1b</b></p>	<p><b>Rozměr:</b> 480x480x150</p>	
<p><b>Váha:</b></p>	<p>38 kg</p>	
<p><b>Zatížení:</b></p>	<p>C250</p>	
<p>Rám</p>		
<p><b>2</b></p>	<p><b>Rozměr:</b> 530x410x100</p>	
<p><b>Váha:</b></p>	<p>28 kg</p>	
<p><b>Zatížení:</b></p>	<p>C250</p>	

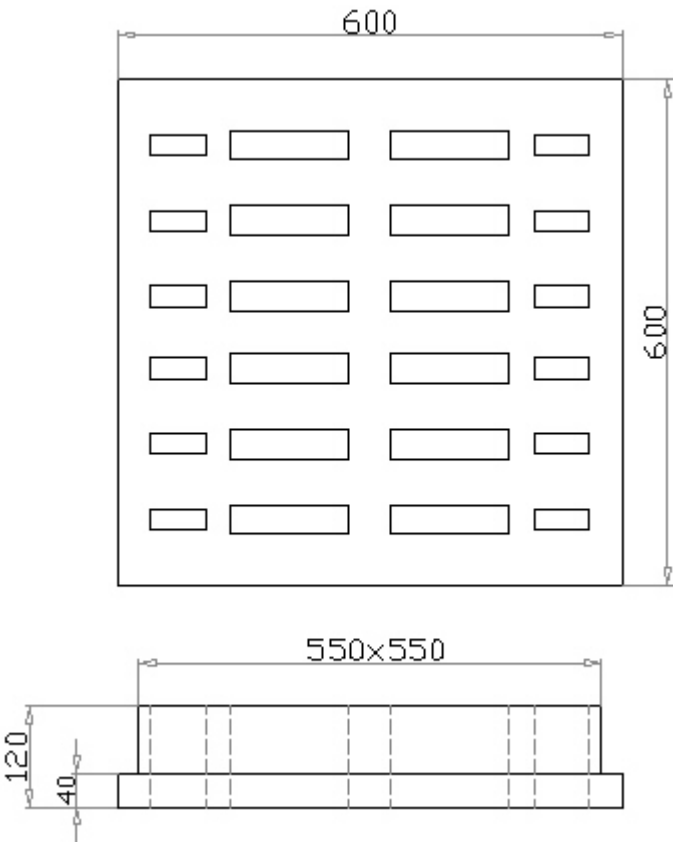

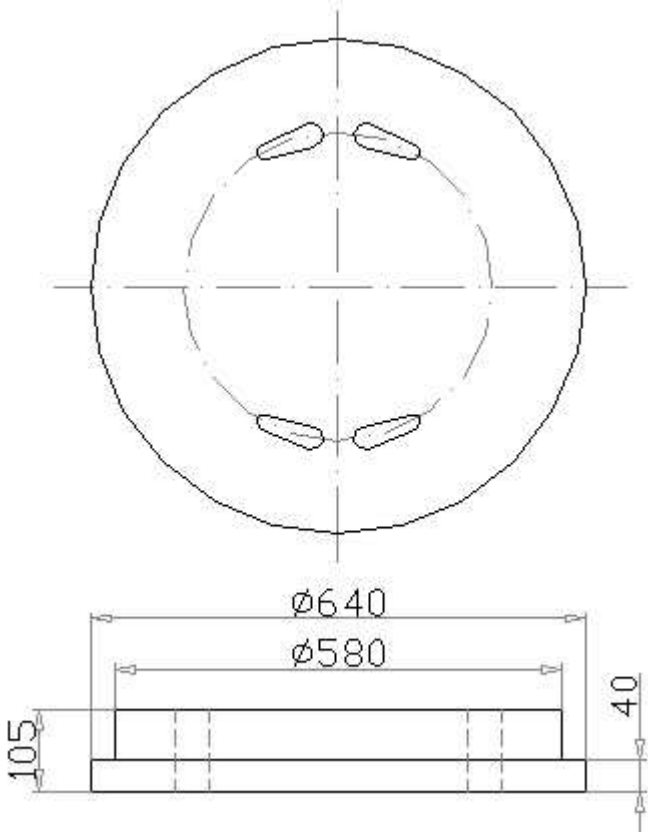

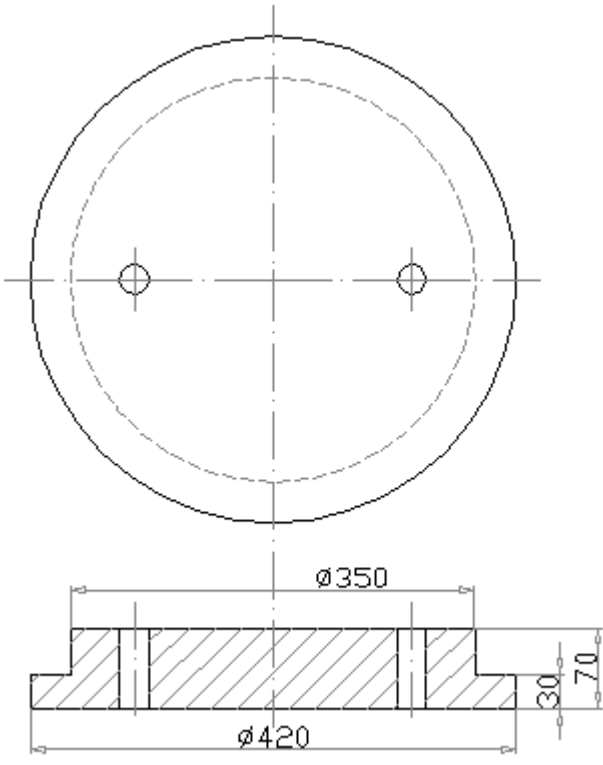
<p><b>3</b></p>	<p><b>Rozměr:</b> 400x400x100</p>	
<p><b>Váha:</b></p>	<p>21 kg</p>	
<p><b>Zatížení:</b></p>	<p>C250</p>	
		
<p><b>4</b></p>	<p><b>Rozměr:</b> 600x500x120</p>	
<p><b>Váha:</b></p>	<p>35 kg</p>	
<p><b>Zatížení:</b></p>	<p>C250</p>	

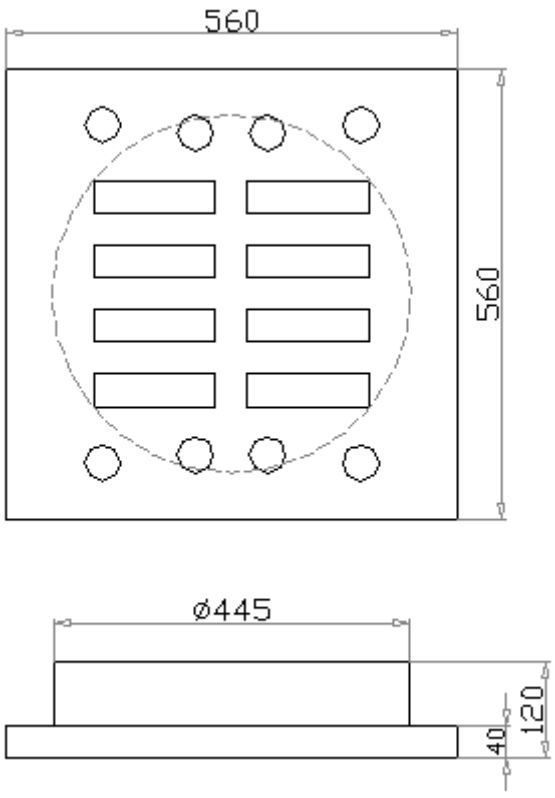



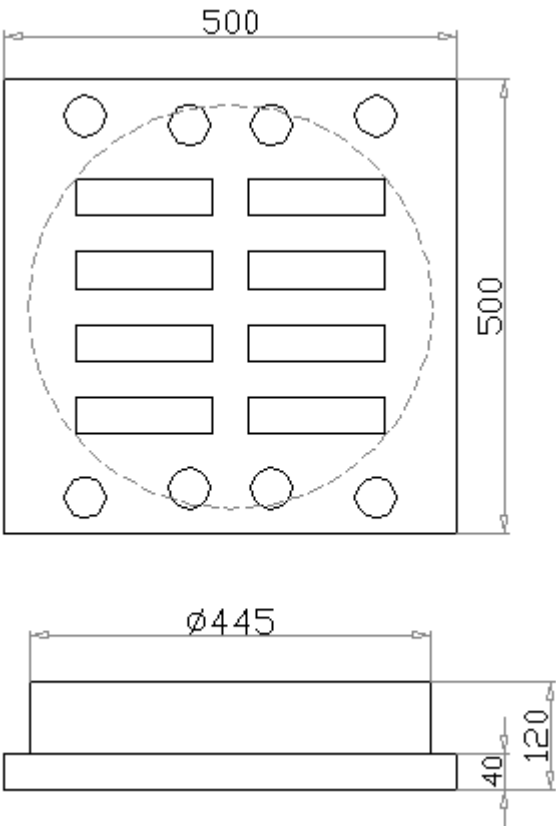

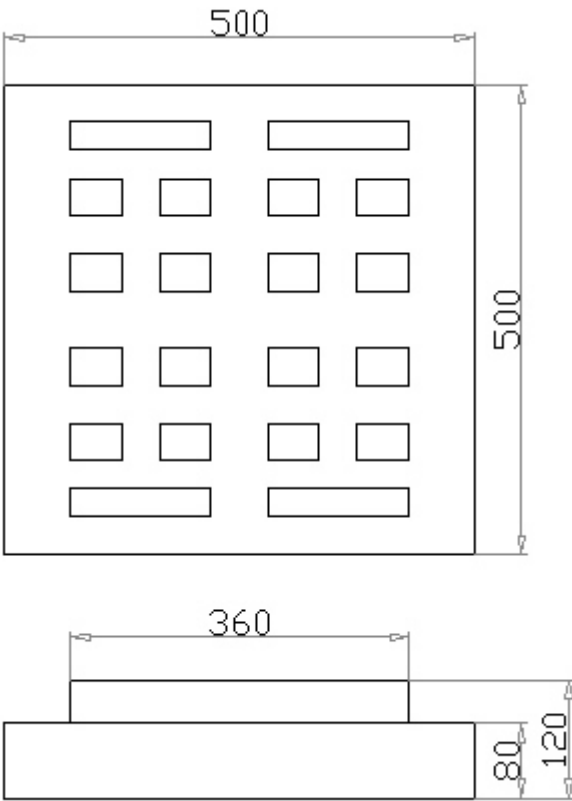

<p><b>5</b></p>	<p><b>Rozměr:</b> 600x400x120</p>	
<p><b>Váha:</b></p>	<p>29 kg</p>	
<p><b>Zatížení:</b></p>	<p>C250</p>	
<p><b>6a</b></p>	<p><b>Rozměr:</b> 480x280x110</p>	
<p><b>Váha:</b></p>	<p>21 kg</p>	
<p><b>Zatížení:</b></p>	<p>C250</p>	

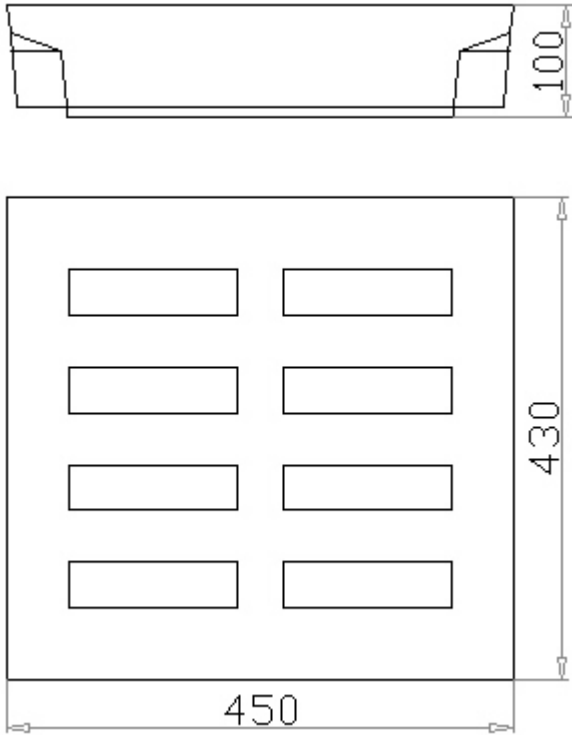

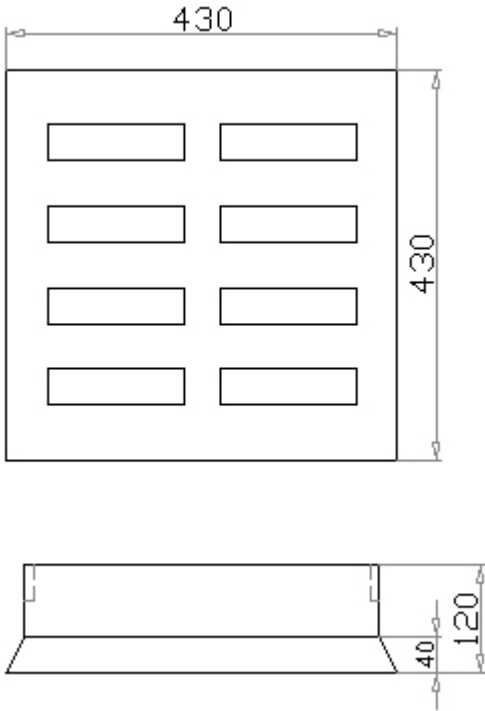
<p><b>6b</b></p>	<p><b>Rozměr:</b> 480x280x150</p>	
<p><b>Váha:</b></p>	<p>31 kg</p>	
<p><b>Zatížení:</b></p>	<p>C250</p>	
		
<p><b>7</b></p>	<p><b>Rozměr:</b> 610x610x120</p>	
<p><b>Váha:</b></p>	<p>47 kg</p>	
<p><b>Zatížení:</b></p>	<p>C250</p>	

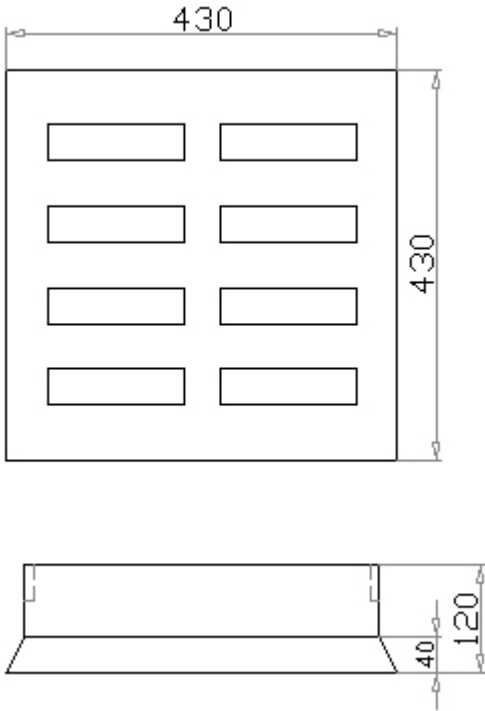
<b>8</b>	<b>Rozměr:</b> 600x600x120		
<b>Váha:</b>	42 kg		
<b>Zatížení:</b>	C250		
<b>9</b>	<b>Rozměr:</b> Ø640x105		
<b>Váha:</b>	45 kg		
<b>Zatížení:</b>	C250		

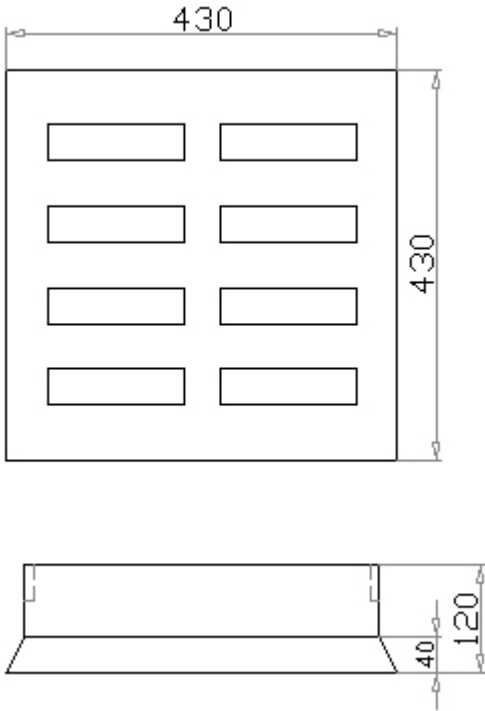
<p><b>10</b></p>	<p><b>Rozměr:</b> Ø420x85</p>	
<p><b>Váha:</b></p>	<p>16 kg</p>	
<p><b>Zatížení:</b></p>	<p>C250</p>	
		
<p><b>11</b></p>	<p><b>Rozměr:</b> 560x560x120</p>	
<p><b>Váha:</b></p>	<p>31 kg</p>	
<p><b>Zatížení:</b></p>	<p>C250</p>	
		

<p><b>12</b></p>	<p><b>Rozměr:</b> 500x500x120</p>	
<p><b>Váha:</b></p>	<p>31 kg</p>	
<p><b>Zatížení:</b></p>	<p>C250</p>	
		
<p><b>13</b></p>	<p><b>Rozměr:</b> 500x500x120</p>	
<p><b>Váha:</b></p>	<p>34 kg</p>	
<p><b>Zatížení:</b></p>	<p>C250</p>	
		

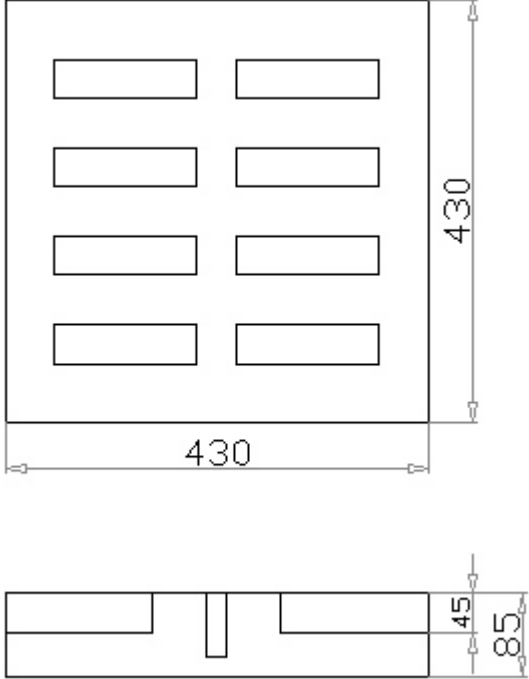
<p><b>14</b></p>	<p><b>Rozměr:</b> 450x430x100</p>										
<p><b>Váha:</b></p>	<p>29 kg</p>										
<p><b>Zatížení:</b></p>	<p>C250</p>										
		<table border="1"> <tbody> <tr> <td data-bbox="140 1191 368 1288"> <p><b>15</b></p> </td> <td data-bbox="368 1191 679 1288"> <p><b>Rozměr:</b> 430x430x120</p> </td> <td data-bbox="679 1191 1457 2047" rowspan="3">  </td> </tr> <tr> <td data-bbox="140 1288 368 1339"> <p><b>Váha:</b></p> </td> <td data-bbox="368 1288 679 1339"> <p>24 kg</p> </td> </tr> <tr> <td data-bbox="140 1339 368 1391"> <p><b>Zatížení:</b></p> </td> <td data-bbox="368 1339 679 1391"> <p>C250</p> </td> </tr> <tr> <td colspan="2" data-bbox="140 1391 679 2047">  </td> </tr> </tbody> </table>	<p><b>15</b></p>	<p><b>Rozměr:</b> 430x430x120</p>		<p><b>Váha:</b></p>	<p>24 kg</p>	<p><b>Zatížení:</b></p>	<p>C250</p>		
<p><b>15</b></p>	<p><b>Rozměr:</b> 430x430x120</p>										
<p><b>Váha:</b></p>	<p>24 kg</p>										
<p><b>Zatížení:</b></p>	<p>C250</p>										
											
<p><b>15</b></p>	<p><b>Rozměr:</b> 430x430x120</p>										
<p><b>Váha:</b></p>	<p>24 kg</p>										
<p><b>Zatížení:</b></p>	<p>C250</p>										
											

<b>16</b>	<b>Rozměr:</b> 430x430x85	
<b>Váha:</b>	23 kg	
<b>Zatížení:</b>	C250	
		
	<b>Rozměr:</b>	
<b>Váha:</b>		
<b>Zatížení:</b>		